

USER MANUAL

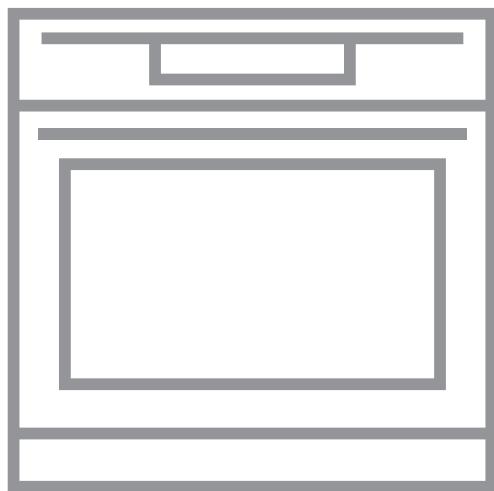

CONTENTS

1. SAFETY INFORMATION.....	2
2. SAFETY INSTRUCTIONS.....	4
3. PRODUCT DESCRIPTION.....	6
4. BEFORE FIRST USE.....	7
5. DAILY USE.....	7
6. USING THE ACCESSORIES.....	10
7. ADDITIONAL FUNCTIONS.....	10
8. HINTS AND TIPS.....	10
9. CARE AND CLEANING.....	24
10. TROUBLESHOOTING.....	26
11. ENERGY EFFICIENCY.....	27

FOR PERFECT RESULTS

Thank you for choosing this AEG product. We have created it to give you impeccable performance for many years, with innovative technologies that help make life simpler features you might not find on ordinary appliances. Please spend a few minutes reading to get the very best from it.

Visit our website for:



Get usage advice, brochures, trouble shooter, service information:
www.aeg.com/webselfservice



Register your product for better service:
www.registeraeg.com



Buy Accessories, Consumables and Original spare parts for your appliance:
www.aeg.com/shop

CUSTOMER CARE AND SERVICE

Always use original spare parts.

When contacting our Authorised Service Centre, ensure that you have the following data available: Model, PNC, Serial Number.

The information can be found on the rating plate.

 Warning / Caution-Safety information

 General information and tips

 Environmental information

Subject to change without notice.

1. SAFETY INFORMATION

Before the installation and use of the appliance, carefully read the supplied instructions. The manufacturer is not responsible for any injuries or damages that are the result of incorrect installation or

usage. Always keep the instructions in a safe and accessible location for future reference.

1.1 Children and vulnerable people safety

- This appliance can be used by children aged from 8 years and above and persons with reduced physical, sensory or mental capabilities or lack of experience and knowledge if they have been given supervision or instruction concerning the use of the appliance in a safe way and understand the hazards involved.
- Children between 3 and 8 years of age and persons with very extensive and complex disabilities shall be kept away unless continuously supervised.
- Children of less than 3 years of age should be kept away unless continuously supervised.
- Do not let children play with the appliance.
- Keep all packaging away from children and dispose of it appropriately.
- Keep children and pets away from the appliance when it operates or when it cools down. Accessible parts are hot.
- If the appliance has a child safety device, it should be activated.
- Children shall not carry out cleaning and user maintenance of the appliance without supervision.

1.2 General Safety

- Only a qualified person must install this appliance and replace the cable.
- The control panel must be connected to specified heating unit with matching colours of connectors, to avoid possible hazard.
- **WARNING:** The appliance and its accessible parts become hot during use. Care should be taken to avoid touching heating elements.
- Always use oven gloves to remove or put in accessories or overware.

- Before carrying out any maintenance, disconnect the appliance from the power supply.
- Ensure that the appliance is switched off before replacing the lamp to avoid the possibility of electric shock.
- Do not use a steam cleaner to clean the appliance.
- Do not use harsh abrasive cleaners or sharp metal scrapers to clean the glass door since they can scratch the surface, which may result in shattering of the glass.
- If the mains power supply cable is damaged, it must be replaced by the manufacturer, its Authorised Service Centre or similarly qualified persons to avoid an electrical hazard.
- To remove the shelf supports first pull the front of the shelf support and then the rear end away from the side walls. Install the shelf supports in the opposite sequence.
- The means for disconnection must be incorporated in the fixed wiring in accordance with the wiring rules.

2. SAFETY INSTRUCTIONS

2.1 Installation



WARNING!

Only a qualified person must install this appliance.

- Remove all the packaging.
- Do not install or use a damaged appliance.
- Follow the installation instructions supplied with the appliance.
- Always take care when moving the appliance as it is heavy. Always use safety gloves and enclosed footwear.
- Do not pull the appliance by the handle.
- The kitchen cabinet and the recess must have suitable dimensions.
- Keep the minimum distance from other appliances and units.
- Install the appliance in a safe and suitable place that meets installation requirements.
- Parts of the appliance carry current. Close the appliance with furniture to

prevent touching the dangerous parts.

- The appliance is equipped with an electric cooling system. It must be operated with the electric power supply.

2.2 Electrical connection



WARNING!

Risk of fire and electric shock.

- All electrical connections should be made by a qualified electrician.
- The appliance must be earthed.
- Make sure that the parameters on the rating plate are compatible with the electrical ratings of the mains power supply.
- Always use a correctly installed shockproof socket.
- Do not use multi-plug adapters and extension cables.

- Make sure not to cause damage to the mains plug and to the mains cable. Should the mains cable need to be replaced, this must be carried out by our Authorised Service Centre.
- Do not let mains cables touch or come near the appliance door, especially when the door is hot.
- The shock protection of live and insulated parts must be fastened in such a way that it cannot be removed without tools.
- Connect the mains plug to the mains socket only at the end of the installation. Make sure that there is access to the mains plug after the installation.
- If the mains socket is loose, do not connect the mains plug.
- Do not pull the mains cable to disconnect the appliance. Always pull the mains plug.
- Use only correct isolation devices: line protecting cut-outs, fuses (screw type fuses removed from the holder), earth leakage trips and contactors.
- The electrical installation must have an isolation device which lets you disconnect the appliance from the mains at all poles. The isolation device must have a contact opening width of minimum 3 mm.
- This appliance complies with the E.E.C. Directives.

2.3 Use



WARNING!

Risk of injury, burns and electric shock or explosion.

- This appliance is for household use only.
- Do not change the specification of this appliance.
- Make sure that the ventilation openings are not blocked.
- Do not let the appliance stay unattended during operation.
- Deactivate the appliance after each use.
- Be careful when you open the appliance door while the appliance is in operation. Hot air can release.

- Do not operate the appliance with wet hands or when it has contact with water.
- Do not apply pressure on the open door.
- Do not use the appliance as a work surface or as a storage surface.
- Open the appliance door carefully. The use of ingredients with alcohol can cause a mixture of alcohol and air.
- Do not let sparks or open flames to come in contact with the appliance when you open the door.
- Do not put flammable products or items that are wet with flammable products in, near or on the appliance.



WARNING!

Risk of damage to the appliance.

- To prevent damage or discoloration to the enamel:
 - do not put ovenware or other objects in the appliance directly on the bottom.
 - do not put aluminium foil directly on the bottom of cavity of the appliance.
 - do not put water directly into the hot appliance.
 - do not keep moist dishes and food in the appliance after you finish the cooking.
 - be careful when you remove or install the accessories.
- Discoloration of the enamel or stainless steel has no effect on the performance of the appliance.
- Use a deep pan for moist cakes. Fruit juices cause stains that can be permanent.
- This appliance is for cooking purposes only. It must not be used for other purposes, for example room heating.
- Always cook with the oven door closed.

2.4 Care and cleaning



WARNING!

Risk of injury, fire, or damage to the appliance.

- Before maintenance, deactivate the appliance and disconnect the mains plug from the mains socket.
- Make sure the appliance is cold. There is the risk that the glass panels can break.
- Replace immediately the door glass panels when they are damaged. Contact the Authorised Service Centre.
- Be careful when you remove the door from the appliance. The door is heavy!
- Clean regularly the appliance to prevent the deterioration of the surface material.
- Clean the appliance with a moist soft cloth. Only use neutral detergents. Do not use any abrasive products, abrasive cleaning pads, solvents or metal objects.
- If you use an oven spray, follow the safety instruction on it's packaging.
- Do not clean the catalytic enamel (if applicable) with any kind of detergent.

2.5 Internal lighting



WARNING!
Risk of electric shock.

- The type of light bulb or halogen lamp used for this appliance is for household appliances only. Do not use it for house lighting.
- Before replacing the lamp, disconnect the appliance from the power supply.
- Only use lamps with the same specifications.

2.6 Service

- To repair the appliance contact an Authorised Service Centre.
- Use original spare parts only.

2.7 Disposal



WARNING!
Risk of injury or suffocation.

- Disconnect the appliance from the mains supply.
- Cut off the mains electrical cable close to the appliance and dispose of it.
- Remove the door catch to prevent children or pets from becoming trapped in the appliance.

3. PRODUCT DESCRIPTION

3.1 General overview

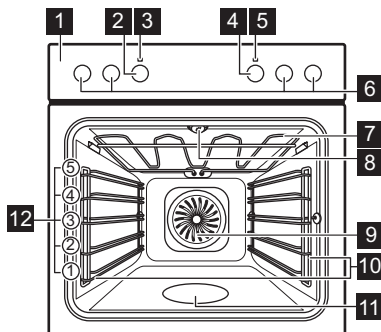

- 1 Control panel
- 2 Knob for the heating functions
- 3 Power lamp / symbol
- 4 Control knob (for the temperature)
- 5 Temperature indicator / symbol
- 6 Knobs for the cooking zones
- 7 Heating element
- 8 Lamp
- 9 Fan
- 10 Shelf support, removable
- 11 Cavity embossment
- 12 Shelf positions

3.2 Accessories

Wire shelf

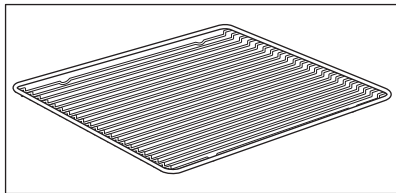

For cookware, cake tins, roasts.

Combi pan

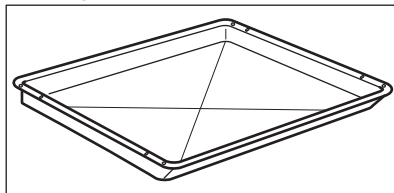

For cakes and biscuits. To bake and roast or as a pan to collect fat.

4. BEFORE FIRST USE



WARNING!
Refer to Safety chapters.

4.1 Initial Cleaning

Remove all accessories and removable shelf supports from the oven.



Refer to "Care and cleaning" chapter.

Clean the oven and the accessories before first use.
Put the accessories and the removable shelf supports back to their initial position.

5. DAILY USE



WARNING!
Refer to Safety chapters.



5.1 Retractable knobs





To use the appliance press the knob. The knob comes out.

5.2 Heating functions

Oven function	Application
0 Off position	The oven is off.
 Light	To turn on the lamp without a cooking function.

Oven function Application

 True Fan Cooking	To bake on up to three shelf positions at the same time and to dry food. Set the temperature 20 - 40 °C lower than for Conventional Cooking.
 Pizza Setting	To bake pizza. To make intensive browning and a crispy bottom.
 Conventional Cooking (Top / Bottom Heat)	To bake and roast food on one shelf position.

Oven function	Application
 Moist Baking	<p>This function is designed to save energy during cooking. For the cooking instructions refer to "Hints and tips" chapter, Moist Baking. The oven door should be closed during cooking so that the function is not interrupted and to ensure that the oven operates with the highest energy efficiency possible. When you use this function, the temperature in the cavity may differ from the set temperature. The heating power may be reduced. For general energy saving recommendations refer to "Energy Efficiency" chapter, Energy Saving. This function was used to comply with the energy efficiency class according to EN 60350-1.</p>
 Defrost	<p>To defrost food (vegetables and fruit). The defrosting time depends on the amount and size of the frozen food.</p>
 True Fan Cooking / True Fan Cooking PLUS	<p>To bake on up to three shelf positions at the same time and to dry food. Set the temperature 20 - 40 °C lower than for Conventional Cooking. To add humidity during the cooking. To get the right colour and crispy crust during baking. To give more juiciness during reheating.</p>
 Grilling	<p>To grill flat food and to toast bread.</p>

Oven function	Application
 Turbo Grilling	<p>To roast larger meat joints or poultry with bones on one shelf position. To make gratins and to brown.</p>

-  The lamp may turn off automatically at a temperature below 60 °C during some oven functions.

5.3 Setting a heating function

1. Turn the knob for the heating functions to select a heating function.
2. Turn the control knob to select the temperature.

The lamp turns on when the oven operates.

3. To turn off the oven, turn the knob for the heating functions to the off position.

5.4 Setting the function: True Fan Cooking PLUS

This function allows to improve humidity during the cooking.

-  **WARNING!**
Risk of burns and damage to the appliance.

Released humidity can cause burns:

- Do not open the oven door when the function works.
- Open the oven door with care after the function stops.

-  Refer to "Hints and tips" chapter.

1. Fill the cavity embossment with tap water.

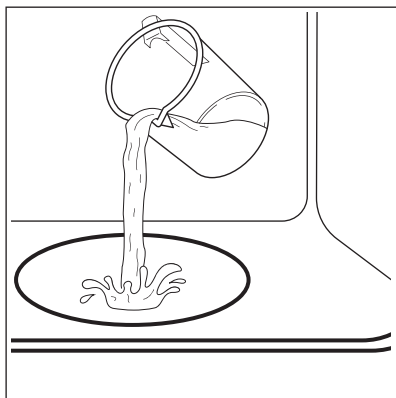



The maximum capacity of the cavity embossment is 250 ml. Fill the cavity embossment with water only when the oven is cold.



CAUTION!

Do not refill the cavity embossment with water during cooking or when the oven is hot.

- Put food in the oven and close the oven door.
- Set the function:  
- Turn the control knob to select a temperature.
- Turn the knob for the heating functions to the off position to turn off the oven.
- Remove water from the cavity embossment.



WARNING!

Make sure that the oven is cold before you remove the remaining water from the cavity embossment.

5.5 Knobs for the cooking zones

You can operate the hob with the knobs for the cooking zones.



You must read the Safety chapters in the hob user manual.

5.6 Heat settings

Knob indication	Function
0	Off position
	Keep warm setting
1 - 9	Heat settings

- Turn the knob to a necessary heat setting.
- To complete the cooking process, turn the knob to the off position.

5.7 Automatic heat-up



Only applicable for hobs with the automatic heat-up function.

The automatic heat-up function heats the cooking zone with full power for some time.

- Turn the knob for the cooking zone clockwise as far as possible (beyond the highest heat setting).
- Immediately set the necessary heat setting.
- To deactivate the function, turn the knob to the off position.

5.8 Using the double zone (if applicable)



To activate the double zone, turn the knob clockwise. Do not turn it through the stop position.

- Turn the knob clockwise to position 9.
- Turn the knob slowly until you can hear a click. The two cooking zones are on.
- To set the necessary heat setting refer to "Heat settings".

6. USING THE ACCESSORIES



WARNING!
Refer to Safety chapters.

6.1 Inserting the accessories

Wire shelf:

Push the shelf between the guide bars of the shelf support .

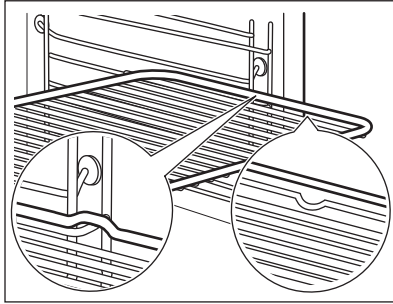

Deep pan:

Push the deep pan between the guide bars of the shelf support.

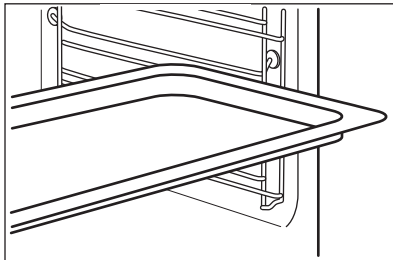

Wire shelf and deep pan together:

Push the deep pan between the guide bars of the shelf support and the wire shelf on the guide bars above.

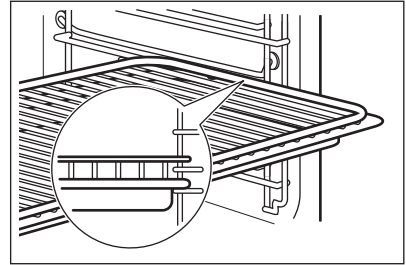

Small indentation at the top increase safety. The indentations are also anti-tip devices. The high rim around the shelf prevents cookware from slipping of the shelf.

7. ADDITIONAL FUNCTIONS

7.1 Cooling fan

When the oven operates, the cooling fan turns on automatically to keep the

surfaces of the oven cool. If you turn off the oven, the cooling fan can continue to operate until the oven cools down.

8. HINTS AND TIPS



WARNING!
Refer to Safety chapters.



The temperature and baking times in the tables are guidelines only. They depend on the recipes and the quality and quantity of the ingredients used.

8.1 Examples of cooking applications for the hob

Heat setting	Application	Time (min)	Hints
1	To keep cooked food warm.	as required	Put a lid on the cookware.
1 - 2	To make Hollandaise sauce, and to melt butter, chocolate and gelatine.	5 - 25	Mix at intervals.
1 - 2	To solidify fluffy omelettes and baked eggs.	10 - 40	Cook with a lid on.
2 - 3	To simmer rice and milk-based dishes, and to heat up ready-cooked meals.	25 - 50	Add a minimum of two times as much liquid as rice. Stir milk dishes halfway through.
3 - 4	To steam vegetables, fish and meat.	20 - 45	Add some tablespoons of a liquid.
4 - 5	To steam potatoes.	20 - 60	Use a maximum of 1/4 l water for 750 g of potatoes.
4 - 5	To cook larger quantities of food, stews and soups.	60 - 150	Add a maximum of 3 l of a liquid to the ingredients.
6 - 7	To lightly fry escalopes, veal cordon bleu, cutlets, rissoles, sausages, liver, eggs, pancakes and doughnuts, and to cook roux.	as required	Turn halfway through.
7 - 8	To fry hash browns, loin steaks and steaks.	5 - 15	Turn halfway through.
9	To boil large quantities of water, to cook pasta, to sear meat (goulash, pot roast) and to deep-fry chips.		

8.2 Cooking recommendations

Your oven may bake or roast differently to the oven you had before. The below tables provide you with the standard settings for temperature, cooking time and shelf position.

If you cannot find the settings for a special recipe, look for the similar one.

8.3 Inner side of the door

On the inner side of the door you can find:

- the numbers of the shelf positions.
- information about the oven functions, recommended shelf positions and temperatures for dishes.

8.4 True Fan Cooking PLUS

Food regeneration

Use the second shelf position.

Use 100 ml of water.

Set the temperature to 110 °C.

Food	Time (min)
Bread rolls	10 - 20
Bread	15 - 25
Focaccia	15 - 25
Meat	15 - 25

Food	Time (min)
Pasta	15 - 25
Pizza	15 - 25
Rice	15 - 25
Vegetables	15 - 25

Roasting
Use the glass baking dish.

Use the second shelf position.

Use 200 ml of water.

Food	Temperature (°C)	Time (min)
Roast beef	200	50 - 60
Chicken	210	60 - 80

8.6 Tips on baking

Baking results	Possible cause	Remedy
The bottom of the cake is not browned sufficiently.	The shelf position is incorrect.	Put the cake on a lower shelf.
The cake sinks and becomes soggy, lumpy or streaky.	The oven temperature is too high.	The next time you bake, set a slightly lower oven temperature.
	The baking time is too short.	Set a longer baking time. You cannot decrease baking times by setting higher temperatures.
	There is too much liquid in the mixture.	Use less liquid. Be careful with mixing times, especially if you use a mixing machine.
The cake is too dry.	The oven temperature is too low.	The next time you bake, set a higher oven temperature.
	The baking time is too long.	The next time you bake, set a shorter baking time.
The cake browns unevenly.	The oven temperature is too high and the baking time is too short.	Set a lower oven temperature and a longer baking time.
	The mixture is unevenly distributed.	Spread the mixture evenly on the baking tray.

Food	Temperature (°C)	Time (min)
Roast pork	180	65 - 80

8.5 Baking

- Use the lower temperature the first time.
- You can extend baking times by 10 – 15 minutes if you bake cakes on more than one shelf position.
- Cakes and pastries at different heights do not always brown equally. There is no need to change the temperature setting if an unequal browning occurs. The differences equalize during baking.
- Trays in the oven can twist during baking. When the trays become cold again, the distortions disappear.

Baking results	Possible cause	Remedy
The cake is not ready in the baking time given.	The oven temperature is too low.	The next time you bake, set a slightly higher oven temperature.

8.7 Baking on one level:

Baking in tins

Food	Function	Temperature (°C)	Time (min)	Shelf position
Ring cake / Brioche	True Fan Cooking	150 - 160	50 - 70	1
Madeira cake / Fruit cakes	True Fan Cooking	140 - 160	70 - 90	1
Flan base - short pastry	True Fan Cooking	170 - 180 ¹⁾	10 - 25	2
Flan base - sponge mixture	True Fan Cooking	150 - 170	20 - 25	2
Cheesecake	Top / Bottom Heat	170 - 190	60 - 90	1

¹⁾ Preheat the oven.

Cakes / pastries / breads on baking trays

Food	Function	Temperature (°C)	Time (min)	Shelf position
Plaited bread / Bread crown	Top / Bottom Heat	170 - 190	30 - 40	3
Christmas stollen	Top / Bottom Heat	160 - 180 ¹⁾	50 - 70	2
Bread (rye bread): 1. First part of baking procedure. 2. Second part of baking procedure.	Top / Bottom Heat	1. 230 ¹⁾ 2. 160 - 180	1. 20 2. 30 - 60	1
Cream puffs / Eclairs	Top / Bottom Heat	190 - 210 ¹⁾	20 - 35	3
Swiss roll	Top / Bottom Heat	180 - 200 ¹⁾	10 - 20	3
Cake with crumble topping (dry)	True Fan Cooking	150 - 160	20 - 40	3
Buttered almond cake / Sugar cakes	Top / Bottom Heat	190 - 210 ¹⁾	20 - 30	3
Fruit flans (made with yeast dough / sponge mixture) ²⁾	True Fan Cooking	150	35 - 55	3

Food	Function	Temperature (°C)	Time (min)	Shelf position
Fruit flans (made with yeast dough / sponge mixture) ²⁾	Top / Bottom Heat	170	35 - 55	3
Fruit flans made with short pastry	True Fan Cooking	160 - 170	40 - 80	3
Yeast cakes with delicate toppings (e.g. quark, cream, custard)	Top / Bottom Heat	160 - 180 ¹⁾	40 - 80	3

1) Preheat the oven.

2) Use a deep pan.

Biscuits

Food	Function	Temperature (°C)	Time (min)	Shelf position
Short pastry biscuits	True Fan Cooking	150 - 160	10 - 20	3
Biscuits made with sponge mixture	True Fan Cooking	150 - 160	15 - 20	3
Pastries made with egg white / Meringues	True Fan Cooking	80 - 100	120 - 150	3
Macaroons	True Fan Cooking	100 - 120	30 - 50	3
Biscuits made with yeast dough	True Fan Cooking	150 - 160	20 - 40	3
Puff pastries	True Fan Cooking	170 - 180 ¹⁾	20 - 30	3
Rolls	True Fan Cooking	160 ¹⁾	10 - 25	3
Rolls	Top / Bottom Heat	190 - 210 ¹⁾	10 - 25	3

1) Preheat the oven.

8.8 Bakes and gratins

Food	Function	Temperature (°C)	Time (min)	Shelf position
Pasta bake	Top / Bottom Heat	180 - 200	45 - 60	1
Lasagne	Top / Bottom Heat	180 - 200	25 - 40	1
Vegetables au gratin ¹⁾	Turbo Grilling	160 - 170	15 - 30	1
Baguettes topped with melted cheese	True Fan Cooking	160 - 170	15 - 30	1
Sweet bakes	Top / Bottom Heat	180 - 200	40 - 60	1
Fish bakes	Top / Bottom Heat	180 - 200	30 - 60	1
Stuffed vegetables	True Fan Cooking	160 - 170	30 - 60	1

¹⁾ Preheat the oven.

8.9 Moist Baking



For best results follow suggestions listed in the table below.

Food	Accessories	Temperature (°C)	Shelf position	Time (min)
Sweet rolls, 16 pieces	baking tray or dripping pan	190	3	45 - 55
Pizza, frozen, 0.35 kg	wire shelf	190	2	45 - 50
Swiss roll	baking tray or dripping pan	180	2	45 - 55
Brownie	baking tray or dripping pan	180	2	55 - 60
Sponge flan base	flan base tin on wire shelf	180	2	40 - 50
Poached fish, 0.3 kg	baking tray or dripping pan	180	3	25 - 35

Food	Accessories	Temperature (°C)	Shelf position	Time (min)
Whole fish, 0.2 kg	baking tray or dripping pan	180	3	25 - 35
Fish fillet, 0.3 kg	pizza pan on wire shelf	180	3	40 - 50
Pouched meat, 0.25 kg	baking tray or dripping pan	190	3	40 - 50
Shashlik, 0.5 kg	baking tray or dripping pan	190	3	35 - 45
Cookies, 16 pieces	baking tray or dripping pan	160	2	40 - 50
Macaroons, 24 pieces	baking tray or dripping pan	150	2	35 - 45
Muffins, 12 pieces	baking tray or dripping pan	160	2	35 - 45
Savory pastry, 20 pieces	baking tray or dripping pan	170	2	35 - 45
Short crust biscuits, 20 pieces	baking tray or dripping pan	150	2	40 - 45
Tartlets, 8 pieces	baking tray or dripping pan	170	2	35 - 45
Poached vegetables, 0.4 kg	baking tray or dripping pan	180	3	45 - 55
Vegetarian omelette	pizza pan on wire shelf	190	3	40 - 50

8.10 Multilevel Baking

Use the function: True Fan Cooking.

Cakes / pastries / breads on baking trays

Food	Temperature (°C)	Time (min)	Shelf position	
			2 positions	3 positions
Cream puffs / Eclairs	160 - 180 ¹⁾	25 - 45	1 / 4	-
Dry streusel cake	150 - 160	30 - 45	1 / 4	-

¹⁾ Preheat the oven.

Biscuits / small cakes / pastries / rolls

Food	Temperature (°C)	Time (min)	Shelf position	
			2 positions	3 positions
Short pastry biscuits	150 - 160	20 - 40	1 / 4	1 / 3 / 5
Biscuits made with sponge mixture	160 - 170	25 - 40	1 / 4	-
Biscuits made with egg white, meringues	80 - 100	130 - 170	1 / 4	-
Macaroons	100 - 120	40 - 80	1 / 4	-
Biscuits made with yeast dough	160 - 170	30 - 60	1 / 4	-
Puff pastries	170 - 180 ¹⁾	30 - 50	1 / 4	-
Rolls	180	20 - 30	1 / 4	-

¹⁾ Preheat the oven.

8.11 Pizza Setting

Food	Temperature (°C)	Time (min)	Shelf position
Pizza (thin crust)	200 - 230 ¹⁾²⁾	15 - 20	2
Pizza (with a lot of topping)	180 - 200	20 - 30	2
Tarts	180 - 200	40 - 55	1
Spinach flan	160 - 180	45 - 60	1
Quiche Lorraine	170 - 190	45 - 55	1
Swiss Flan	170 - 190	45 - 55	1
Cheesecake	140 - 160	60 - 90	1
Apple cake, covered	150 - 170	50 - 60	1
Vegetable pie	160 - 180	50 - 60	1
Unleavened bread	230 - 250 ¹⁾	10 - 20	2
Puff pastry flan	160 - 180 ¹⁾	45 - 55	2
Flammekuchen (Pizza-like dish from Alsace)	230 - 250 ¹⁾	12 - 20	2

Food	Temperature (°C)	Time (min)	Shelf position
Piroggen (Russian version of calzone)	180 - 200 ¹⁾	15 - 25	2

1) Preheat the oven.

2) Use a deep pan.

8.12 Roasting

Use heat-resistant ovenware.

Roast large roasting joints directly in the tray or on the wire shelf placed above the tray.

Put some water in the tray to prevent the meat juices or fat from burning.

Meat with crackling can be roasted in the roasting tin without the lid.

Turn the roast after 1/2 - 2/3 of the cooking time.

To keep meat more succulent:

- roast lean meat in the roasting tin with the lid or use roasting bag.
- roast meat and fish in large pieces (1 kg or more).
- baste large roasts and poultry with their juices several times during roasting.

8.13 Roasting tables

Beef

Food	Quantity	Function	Temperature (°C)	Time (min)	Shelf position
Pot roast	1 - 1.5 kg	Top / Bottom Heat	230	120 - 150	1
Roast beef or fillet: rare	per cm of thickness	Turbo Grilling	190 - 200 ¹⁾	5 - 6	1
Roast beef or fillet: medium	per cm of thickness	Turbo Grilling	180 - 190 ¹⁾	6 - 8	1
Roast beef or fillet: well done	per cm of thickness	Turbo Grilling	170 - 180 ¹⁾	8 - 10	1

1) Preheat the oven.

Pork

Food	Quantity (kg)	Function	Temperature (°C)	Time (min)	Shelf position
Shoulder / Neck / Ham joint	1 - 1.5	Turbo Grilling	160 - 180	90 - 120	1
Chop / Spare rib	1 - 1.5	Turbo Grilling	170 - 180	60 - 90	1

Food	Quantity (kg)	Function	Temperature (°C)	Time (min)	Shelf position
Meatloaf	0.75 - 1	Turbo Grilling	160 - 170	50 - 60	1
Pork knuckle (precooked)	0.75 - 1	Turbo Grilling	150 - 170	90 - 120	1

Veal

Food	Quantity (kg)	Function	Temperature (°C)	Time (min)	Shelf position
Roast veal	1	Turbo Grilling	160 - 180	90 - 120	1
Knuckle of veal	1.5 - 2	Turbo Grilling	160 - 180	120 - 150	1

Lamb

Food	Quantity (kg)	Function	Temperature (°C)	Time (min)	Shelf position
Leg of lamb / Roast lamb	1 - 1.5	Turbo Grilling	150 - 170	100 - 120	1
Saddle of lamb	1 - 1.5	Turbo Grilling	160 - 180	40 - 60	1

Game

Food	Quantity (kg)	Function	Temperature (°C)	Time (min)	Shelf position
Saddle / Leg of hare	up to 1	Top / Bottom Heat	230 ¹⁾	30 - 40	1
Saddle of venison	1.5 - 2	Top / Bottom Heat	210 - 220	35 - 40	1
Haunch of venison	1.5 - 2	Top / Bottom Heat	180 - 200	60 - 90	1

¹⁾ Preheat the oven.

Poultry

Food	Quantity (kg)	Function	Temperature (°C)	Time (min)	Shelf position
Poultry portions	0.2 - 0.25 each	Turbo Grilling	200 - 220	30 - 50	1
Half chicken	0.4 - 0.5 each	Turbo Grilling	190 - 210	35 - 50	1

Food	Quantity (kg)	Function	Temperature (°C)	Time (min)	Shelf position
Chicken, poulard	1 - 1.5	Turbo Grilling	190 - 210	50 - 70	1
Duck	1.5 - 2	Turbo Grilling	180 - 200	80 - 100	1
Goose	3.5 - 5	Turbo Grilling	160 - 180	120 - 180	1
Turkey	2.5 - 3.5	Turbo Grilling	160 - 180	120 - 150	1
Turkey	4 - 6	Turbo Grilling	140 - 160	150 - 240	1

Fish (steamed)

Food	Quantity (kg)	Function	Temperature (°C)	Time (min)	Shelf position
Whole fish	1 - 1.5	Top / Bottom Heat	210 - 220	40 - 60	1

8.14 Grilling

- Always grill with the maximum temperature setting.
- Set the shelf into the shelf position as recommended in the grilling table.
- Always set the pan to collect the fat into the first shelf position.

- Grill only flat pieces of meat or fish.
- Always preheat the empty oven with the grill functions for 5 minutes.



CAUTION!

Always grill with the oven door closed.

Grilling

Food	Temperature (°C)	Time (min)		Shelf position
		1st side	2nd side	
Roast beef	210 - 230	30 - 40	30 - 40	2
Filet of beef	230	20 - 30	20 - 30	3
Back of pork	210 - 230	30 - 40	30 - 40	2
Back of veal	210 - 230	30 - 40	30 - 40	2
Back of lamb	210 - 230	25 - 35	20 - 25	3
Whole Fish, 500 - 1000 g	210 - 230	15 - 30	15 - 30	3 / 4

8.15 Frozen Foods

Use the function True Fan Cooking.

Food	Temperature (°C)	Time (min)	Shelf position
Pizza, frozen	200 - 220	15 - 25	2
Pizza American, frozen	190 - 210	20 - 25	2
Pizza, chilled	210 - 230	13 - 25	2
Pizza Snacks, frozen	180 - 200	15 - 30	2
French Fries, thin	200 - 220	20 - 30	3
French Fries, thick	200 - 220	25 - 35	3
Wedges / Croquettes	220 - 230	20 - 35	3
Hash Browns	210 - 230	20 - 30	3
Lasagne / Cannelloni, fresh	170 - 190	35 - 45	2
Lasagne / Cannelloni, frozen	160 - 180	40 - 60	2
Oven baked cheese	170 - 190	20 - 30	3
Chicken Wings	190 - 210	20 - 30	2

8.16 Defrost

- Remove the food packaging and put the food on a plate.
- Use the first shelf position from the bottom.
- Do not cover the food with a bowl or a plate, as this can extend the defrost time.
- For large portions of food place an upturned empty plate on the bottom of the oven cavity. Put the food in a deep plate or dish and set it on top of the plate inside the oven. Remove shelf supports if necessary.

Food	Quantity (kg)	Defrosting time (min)	Further defrosting time (min)	Comments
Chicken	1	100 - 140	20 - 30	Put the chicken on an upturned saucer in a big plate. Turn halfway through.
Meat	1	100 - 140	20 - 30	Turn halfway through.
Trout	0.15	25 - 35	10 - 15	-
Strawberries	0.3	30 - 40	10 - 20	-
Butter	0.25	30 - 40	10 - 15	-

Food	Quantity (kg)	Defrosting time (min)	Further defrosting time (min)	Comments
Cream	2 x 0.2	80 - 100	10 - 15	Whip the cream when still slightly frozen in places.
Gateau	1.4	60	60	-

8.17 Drying - True Fan Cooking

For a better result, stop the oven halfway through the drying time, open the door and let it cool down for one night to complete the drying.

Cover trays with grease proof paper or baking parchment.

Vegetables

For one tray use the third shelf position.

For 2 trays use the first and fourth shelf position.

Food	Temperature (°C)	Time (h)
Beans	60 - 70	6 - 8
Peppers	60 - 70	5 - 6
Vegetables for sour	60 - 70	5 - 6
Mushrooms	50 - 60	6 - 8
Herbs	40 - 50	2 - 3

Fruit

Food	Temperature (°C)	Time (h)	Shelf position	
			1 position	2 positions
Plums	60 - 70	8 - 10	3	1 / 4
Apricots	60 - 70	8 - 10	3	1 / 4
Apple slices	60 - 70	6 - 8	3	1 / 4
Pears	60 - 70	6 - 9	3	1 / 4

8.18 Information for test institutes

Tests according to EN 60350-1:2013 and IEC 60350-1:2011.

Baking on one level. Baking in tins

Food	Function	Temperature (°C)	Time (min)	Shelf position
Fatless sponge cake	True Fan Cooking	140 - 150	35 - 50	2
Fatless sponge cake	Top / Bottom Heat	160	35 - 50	2
Apple pie (2 tins Ø20 cm, diagonally off set)	True Fan Cooking	160	60 - 90	2
Apple pie (2 tins Ø20 cm, diagonally off set)	Top / Bottom Heat	180	70 - 90	1

Baking on one level. Biscuits

Use the third shelf position.

Food	Function	Temperature (°C)	Time (min)
Short bread / Pastry stripes	True Fan Cooking	140	25 - 40
Short bread / Pastry stripes	Top / Bottom Heat	160 ¹⁾	20 - 30
Small cakes (20 per tray)	True Fan Cooking	150 ¹⁾	20 - 35
Small cakes (20 per tray)	Top / Bottom Heat	170 ¹⁾	20 - 30

¹⁾ Preheat the oven.

Multilevel Baking. Biscuits

Food	Function	Temperature (°C)	Time (min)	Shelf position	
				2 positions	3 positions
Short bread / Pastry Stripes	True Fan Cooking	140	25 - 45	1 / 4	1 / 3 / 5
Small cakes (20 per tray)	True Fan Cooking	150 ¹⁾	23 - 40	1 / 4	-

¹⁾ Preheat the oven.

Grilling

Preheat the empty oven for 5 minutes.

Grill with the maximum temperature setting.

Food	Function	Time (min)	Shelf position
Toast	Grilling	1 - 3	5
Beef Steak	Grilling	24 - 30 ¹⁾	4

¹⁾ Turn halfway through.

9. CARE AND CLEANING



WARNING!
Refer to Safety chapters.

9.1 Notes on cleaning

Clean the front of the oven with a soft cloth with warm water and a mild cleaning agent.

To clean metal surfaces, use a dedicated cleaning agent.

Clean the oven interior after each use. Fat accumulation or other food remains may result in a fire. The risk is higher for the grill pan.

Clean all accessories after each use and let them dry. Use a soft cloth with warm water and a cleaning agent. Do not clean the accessories in the dishwasher.

Clean stubborn dirt with a special oven cleaner.

If you have nonstick accessories, do not clean them using aggressive agents, sharp-edged objects or a dishwasher. It can cause damage to the nonstick coating.

Clean the moisture from the cavity after each use.

9.2 Cleaning the cavity embossment

The cleaning procedure removes limestone residue from the cavity embossment after cooking with steam.



For the function: True Fan Cooking PLUS we recommend to do the cleaning procedure at least every 5 - 10 cooking cycles.

1. Put 250 ml of white vinegar into the cavity embossment at the bottom of the oven.
Use maximum 6% vinegar without any additives.
2. Let the vinegar dissolve the residual limestone at the ambient temperature for 30 minutes.
3. Clean the cavity with warm water and a soft cloth.

9.3 Removing the shelf supports

To clean the oven, remove the shelf supports.



CAUTION!
Be careful when you remove the shelf supports.

1. Pull the front of the shelf support away from the side wall.

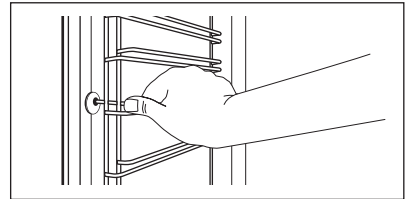

2. Pull the rear end of the shelf support away from the side wall and remove it.

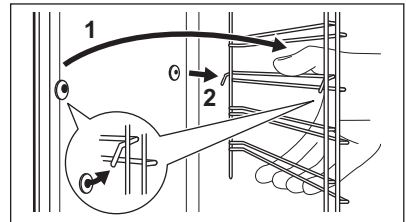

Install the removed accessories in the opposite sequence.

9.4 Oven ceiling



WARNING!
Deactivate the appliance before you remove the heating element. Make sure that the appliance is cold. There is a risk of burns.

Remove the shelf supports.

You can fold down the heating element on the oven ceiling to clean the oven ceiling easily.

1. Hold the heating element with two hands at the front.
2. Pull it forwards against the spring pressure and out of two holders.

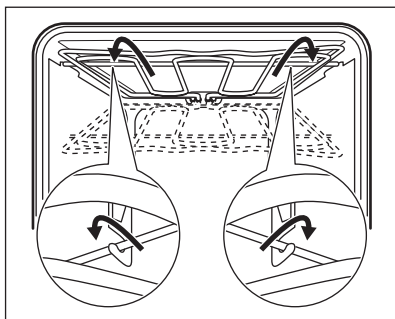

The heating element folds down.

3. Clean the oven ceiling.
4. Install the heating element in the opposite sequence.

i Install the heating element correctly above the supports on the inner walls of the appliance.

5. Install the shelf supports.

9.5 Removing and installing the door

You can remove the door and the internal glass panels to clean it. The number of glass panels is different for different models.

! **WARNING!**
The door is heavy.

1. Open the door fully.
2. Fully press the clamping levers (A) on the two door hinges.

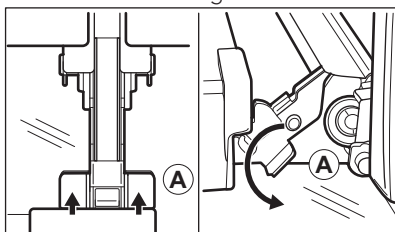

3. Close the oven door to the first opening position (approximately 70° angle).
4. Hold the door with one hand on each side and pull it away from the oven at an upwards angle.

5. Put the door with the outer side down on a soft cloth on a stable surface.
6. Hold the door trim (B) on the top edge of the door at the two sides and push inwards to release the clip seal.

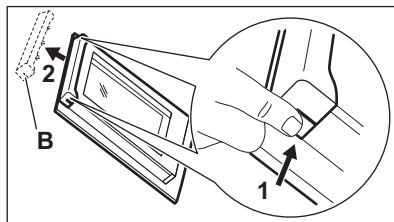

7. Pull the door trim to the front to remove it.
8. Hold the door glass panels on their top edge one by one and pull them up out of the guide.

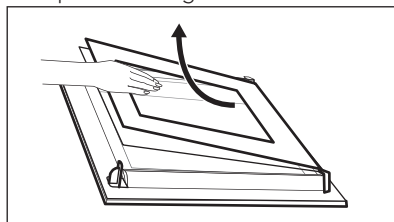

9. Clean the glass panel with water and soap. Dry the glass panel carefully. When the cleaning is completed, do the above steps in the opposite sequence. Install the smaller panel first, then the larger and the door.

! **WARNING!**
Make sure that the glasses are inserted in the correct position otherwise the surface of the door may overheat.

9.6 Replacing the lamp

! **WARNING!**
Risk of electric shock.
The lamp can be hot.

1. Turn off the oven. Wait until the oven is cooled down.
2. Disconnect the oven from the mains.
3. Put a cloth on the bottom of the cavity.

The top lamp

1. Turn the lamp glass cover to remove it.

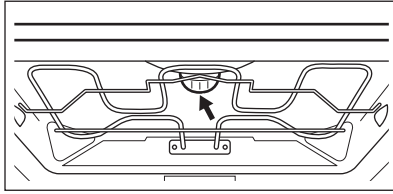

2. Clean the glass cover.
3. Replace the lamp with a suitable 300 °C heat-resistant lamp.
4. Install the glass cover.

10. TROUBLESHOOTING



WARNING!

Refer to Safety chapters.

10.1 What to do if...

Problem	Possible cause	Remedy
The cooking zones do not operate.	Refer to the operating instructions for the built-in cooking surface.	
The oven does not heat up.	The oven is deactivated.	Activate the oven.
The oven does not heat up.	The fuse is blown.	Make sure that the fuse is the cause of the malfunction. If the fuse is blown again and again, contact a qualified electrician.
The lamp does not operate.	The lamp is defective.	Replace the lamp.
Steam and condensation settle on the food and in the cavity of the oven.	You left the dish in the oven for too long.	Do not leave the dishes in the oven for longer than 15 - 20 minutes after the cooking process ends.
There is no good cooking performance using the function: True Fan Cooking PLUS.	You did not turn on the function: True Fan Cooking PLUS.	Refer to "Activating the function: True Fan Cooking PLUS".
The water in the cavity embossment does not boil.	The temperature is too low.	Set the temperature at least to 110 °C. Refer to "Hints and tips" chapter.

Problem	Possible cause	Remedy
The water comes out of the cavity embossment.	There is too much water in the cavity embossment.	Deactivate the oven and make sure that the appliance is cold. Wipe the water with a cloth or sponge. Add the correct amount of water to the cavity embossment. Refer to the specific procedure.

10.2 Service data

If you cannot find a solution to the problem yourself, contact your dealer or an Authorised Service Centre.

The necessary data for the service centre is on the rating plate. The rating plate is

on the front frame of the oven cavity. Do not remove the rating plate from the oven cavity.

We recommend that you write the data here:	
Model (MOD.)
Product number (PNC)
Serial number (S.N.)

11. ENERGY EFFICIENCY

11.1 Product Fiche and information according to EU 65-66/2014

Supplier's name	AEG
Model identification	EEB350010M
Energy Efficiency Index	95.3
Energy efficiency class	A
Energy consumption with a standard load, conventional mode	0.99 kWh/cycle
Energy consumption with a standard load, fan-forced mode	0.81 kWh/cycle
Number of cavities	1
Heat source	Electricity
Volume	71 l
Type of oven	Built-Under Oven
Mass	32.0 kg

EN 60350-1 - Household electric cooking appliances - Part 1: Ranges, ovens, steam ovens and grills - Methods for measuring performance.

11.2 Energy saving



The oven contains features which help you save energy during everyday cooking.

General hints

Make sure that the oven door is closed properly when the oven operates. Do not open the door too often during cooking. Keep the door gasket clean and make sure it is well fixed in its position.

Use metal dishes to improve energy saving.

When possible, do not preheat the oven before you put the food inside.

When the cooking duration is longer than 30 minutes, reduce the oven

temperature to minimum 3 - 10 minutes before the end of the cooking time, depending on the duration of the cooking. The residual heat inside the oven will continue to cook.

Use the residual heat to warm up other dishes.

Keep breaks between baking as short as possible when you prepare few dishes at one time.

Cooking with fan

When possible, use the cooking functions with fan to save energy.

Keep food warm

Choose the lowest possible temperature setting to use residual heat and keep a meal warm.

Moist Baking

Function designed to save energy during cooking.

12. ENVIRONMENTAL CONCERNS

Recycle materials with the symbol . Put the packaging in relevant containers to recycle it. Help protect the environment and human health by recycling waste of electrical and electronic appliances. Do not dispose of

appliances marked with the symbol  with the household waste. Return the product to your local recycling facility or contact your municipal office.

www.aeg.com/shop



867352155-B-302018



AEG